

The Minelab Eureka Gold

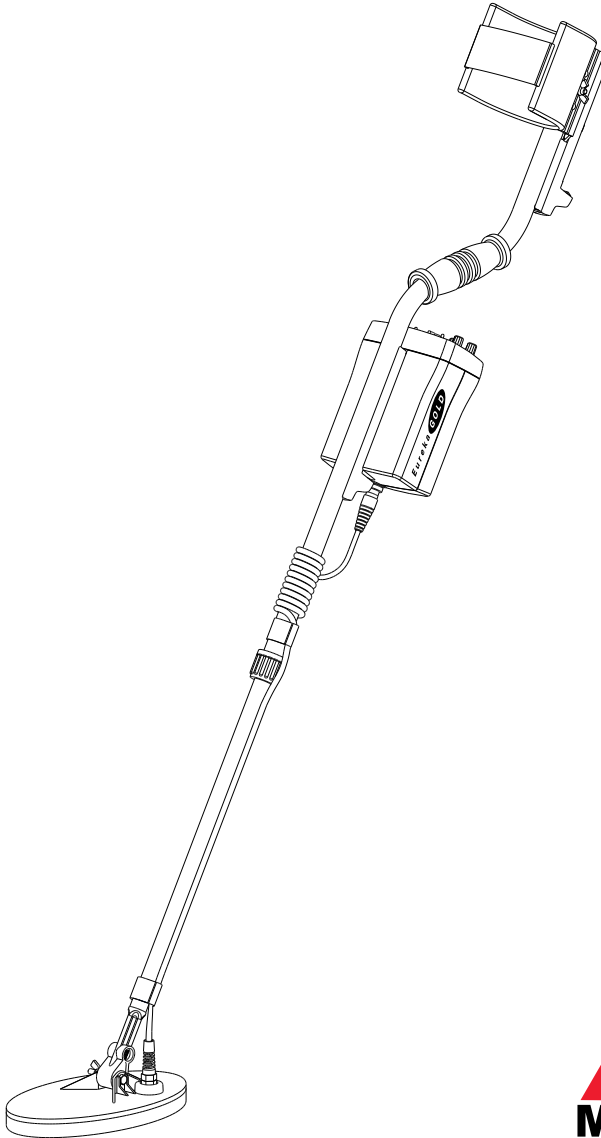

INSTRUCTION MANUAL

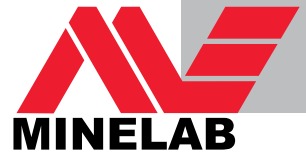

WARNING

THIS DOCUMENT CONTAINS
MINELAB ELECTRONICS PTY LTD
LIMITED RIGHTS TECHNICAL DATA, OR
RESTRICTED RIGHTS DATA, OR BOTH.

© Minelab Electronics Pty Ltd

This work is copyright. Apart from any use
as permitted under the *Copyright Act 1968*,
no part may be reproduced by any process
without written permission from
Minelab Electronics Pty Ltd,
118 Hayward Avenue,
Torrensville SA 5031, Australia.

Minelab Eureka Gold Instruction Manual

CONTENTS

	Page
1. Introduction	4
2. List of Parts	5
3. Assembling the Detector	6
3.1 Armrest/Upper Shaft Assembly	6
3.2 Lower Shaft Assembly	6
3.3 Completing the Shaft Assembly	7
3.4 Shaft Mount	7
3.5 Rear Shaft Mount	8
3.6 Hipmounting/Chestmount	9
4. Batteries	10
4.1 Installation of NiMH Battery Pack	10
4.2 Installation of Alkaline Batteries	11
4.3 Low Battery Warning and NiMH Recharging.....	12
4.4 Using your NiMH Chargers.....	12
5. The Eureka Gold Controls	13
5.1 Volume Control	13
5.2 Threshold Control	13
5.3 Sensitivity Control	15
5.4 Frequency Switch	16
5.5 Signal Switch	16
5.6 Balance Switch	17
5.7 Mode Switch	17
5.8 Tone.....	18
5.9 Headphones.....	18
5.9 Coils.....	19

6. Quickstart Operating Instructions	20
6.1 Best Setup Positions.....	21
7. Detector Sounds	22
8. Operating Instructions - Fundamentals	23
8.1 Operating the Eureka Gold.....	23
8.2 Ground Balance.....	24
9. Detecting Techniques	25
9.1 Sweeping.....	26
9.2 Pinpointing the Target.....	27
9.3 Digging the Target.....	28
9.4 Automatic Ground Balancing.....	29
10. Discrimination	31
10.1 Discrimination of Iron Targets	31
10.2 Discriminating in 'Hot' Ground	31
10.1 Discriminating within Holes	32
11. Prospecting Tips	33
11.1 Mineralisation and 'Hot' Rocks	33
11.2 Clay Domes	34
11.3 Charcoal	34
11.4 Gold Lore	35
12. The Coil and Skidplate	36
13. Environmental Concerns	37
14. Care of the Detector	38
14.1 Trouble-shooting Guide	40
15. Warranty and Service	41
16. Specifications	42
17. FCC Compliance and EC Conformity Notes	43
18. Minelab Service Repair Form	44

1. Introduction

Congratulations on purchasing Minelab's Eureka Gold prospecting detector. The Eureka Gold can constantly and automatically adjust the Ground Balance to keep it at the correct setting. This will ensure that the detector is always operating to its optimum strength, reducing operator fatigue and allowing more ground to be covered in a day's detecting.

For sensitivity to a wide range of targets, the Eureka Gold has a choice of three operating frequencies:

- 6.4 kHz
- 20 kHz
- 60 kHz

Further refinements include target detection with pitch variation, better signal-to-noise ratio in the electronics, and a 10" (25cm) Elliptical Double 'D' coil as standard equipment.

This manual has been arranged with QuickStart instruction for inexperienced users. More detailed notes about assembling the detector, how its controls work and methods of detecting are also included and well worth reading by all operators.

As always at Minelab Electronics, we strive to provide you with the best metal detection equipment possible. With that in mind we present the Eureka Gold - the best continuous wave prospecting detector available today.

If you have any questions or comments we would like to hear from you. Please contact your local authorised Minelab Dealer or write to us direct.

We wish you every success in your prospecting and treasure hunting.

Since there may be a range of options available in this detector type, equipment may vary according to the model or country of issue. Certain descriptions and illustrations may differ (in this manual) from the exact model that you have purchased. In addition, Minelab reserve the right to respond to ongoing technical progress by introducing changes in design, equipment and technical features at any time.

2. List of Parts

The box in which the Eureka Gold is shipped should contain the following items. When you first receive your Eureka Gold check that all these items are in the box:

- Eureka Gold Control Box
- 10" (25cm) Elliptical Coil with Skidplate attached
- 2-Piece Shaft Assembly including fibreglass lower shaft
- Aluminium 2-Piece Armrest (including nuts and bolts)
- Control Box Rear-mounting Bracket
- NiMH Battery Pack
- Mains power NiMH Battery Charger
- Neoprene Armrest Cover
- 2 Piece Armrest Strap
- Velcro Straps (2)
- Teardrop Washers
- Warranty Card
- User Manual
- Detector Stand

Please enter the required details on your warranty card and mail it to Minelab Electronics Pty Ltd. It is extremely important that we receive your warranty card within 14 days of date of purchase to register your new detector on our warranty file.

The following accessories are also available to further improve your detector:

- 12v NiMH Battery Vehicle Charger
- 11" Round Double 'D' Coil
- 15" Spider Double 'D' Coil
- Hipmount Bag
- Alkaline Battery pack
- Padded Cordura Detector Transport Bag
- Minelab Cap
- Minelab Polo shirt
- Minelab Jacket

3. Assembling the Detector

Please follow these instructions to assemble the Eureka Gold. Refer to the drawings to identify parts and how they are positioned. Please contact your Minelab dealer for further instructions should any difficulties arise.

3.1 Armrest/Upper Shaft Assembly

a) Place the two armrest halves (4) on either side of the upper shaft (2) and ensure that the bolt hole is aligned.

b) Slide the nylon bolts through the bolt holes and screw the nylon wing nuts (12) onto the bolts with a couple of turns (do not tighten).

c) Slide the detector stand (7) into the runners of the armrest (4) and tighten the nylon wing nuts by hand.

d) Attach the armrest straps (6) using the press studs on both sides of the armrest.

e) Push the armrest straps through the slots in the armrest cover (5) and push the cover over the armrest.

3.2 Lower Shaft Assembly

a) Remove the tape on the lower fibreglass tube (3) that is holding the black teardrop washers (10) in place.

Note: Ensure the washers do not fall out after removing the tape.

b) Remove the black nylon wing nut (12), and bolt (11) from the coil (9).

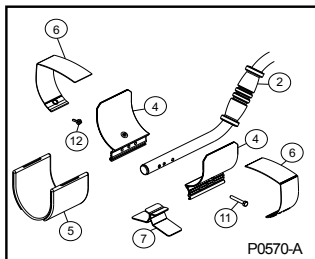

Figure 2 - Armrest/Upper Shaft Assembly

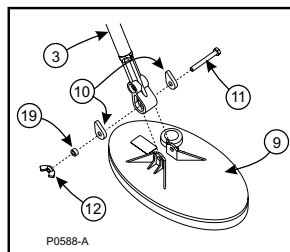

Figure 3 - The Coil and Lower Shaft Assembly

c) With the teardrop washers in place, push the lower tube (3) into the coil bracket so that the holes line up.

Note: Ensure that the black nylon spring clip near the top of the fibreglass tube is pointing toward the rear of the coil.

d) Push the black nylon bolt (11) through the holes in the bracket on the coil from the cable entry side, put on the spacer (19) and tighten the wing nut (12) by hand.

3.3 Completing the Shaft Assembly

a) Slide the lower shaft assembly (3) into the Aluminium upper shaft (2).

Note: The black plastic locking nut (18) may need to be loosened to position the lower shaft assembly correctly.

b) Set the length of the shaft by locking the black nylon spring clip into one of the holes provided, then tighten the plastic locking nut.

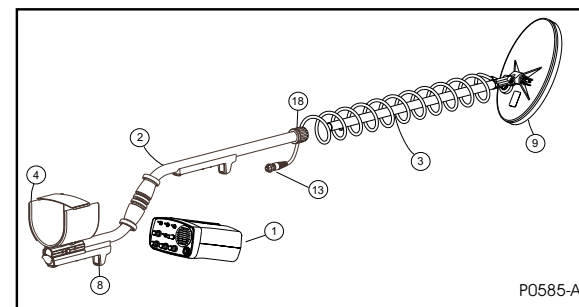

Figure 4 - Completing the Shaft Assembly

3.4 Shaft Mount

a) Position the control box so that the recess in the control box (1) is aligned with the leading edge of the mounting clip (8). Push the forward section of the control box upwards until the trigger 'clicks' indicating the control box is secured (see figure 5).

- b) Firmly wind between 17 and 20 turns of the cable around the shaft until it reaches the control box.

Note: Leave enough slack at the bottom of the cable near the coil to adjust the coil position without straining the coil cable.

- c) Connect the coil connector (13) to the plug on the rear of the control box (14).

- d) Use Velcro™ tabs to secure cable in the correct position on the shaft maintaining slack at coil and control box.

Note: Weather Protection - The hipmount bag is designed so that it can be used to weatherproof your control box while detecting in inclement weather. The new design allows the hipmount bag to protect the control box while still on the shaft. The control box is positioned into the hipmount bag with the slot for the mounting bracket positioned at the back. The velcroed panel is then wrapped across the top of the stem. The hipmount bag is available from your supplier as an accessory item.

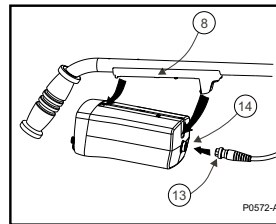

Figure 5 - Mounting the Control Box on the Shaft

3.5 Rear Shaft Mount

The Eureka Gold provides the option of mounting the control box at the rear of the shaft (2), beneath the armrest.

In order to mount the control box (1) in this position:

- a) Loosen the nylon wing nut from the armrest and remove the detector stand.

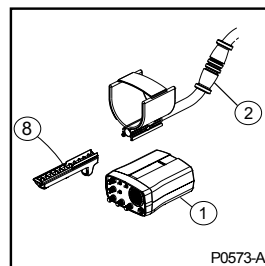

Figure 6 - Mounting the Control Box to the Rear of the Shaft

- b) Slide in the black plastic rear control box bracket (8).
- c) Tighten the nylon wing nut on the armrest.
- d) Clip the control box onto the rear mounting bracket (see figure 5).
- e) Firmly wind the cable up the stem using the Velcro™ tabs to hold in position.
- f) Connect the coil connector (13) to the plug (14) on the rear of the control box.

3.6 Hipmounting/Chestmount

Hipmounting is an alternative to mounting the detector on the shaft and significantly reduces physical strain, enabling longer search time without undue fatigue. A hipmount bag is available as an accessory item for this purpose.

- a) Check that there are charged batteries in the control box.
- b) Place the control box into the hipmount bag with its control panel facing outwards (see figure 7).
- c) Place the hipmount bag in your preferred working configuration. The hipmount bag can be worn on the belt or over the shoulder.

Note: If mounting the hipmount bag on the chest, a belt can be thread through the belt loop and around the chest to hold the bag in position.

- d) Wind about 5 turns of the cable around the shaft. This will reduce the amount of excess cable.

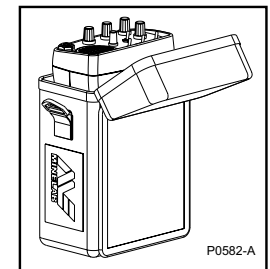

Figure 7 - Hipmounting the Control Box

Note: Leave enough slack at the bottom of the cable near the coil to adjust the coil position without straining the coil cable.

- e) Use Velcro™ tabs to secure the cable in position at the base of the shaft and where the cable leaves the shaft.
- f) Take the excess loose coil cable and wind it through the belt bracket of the hipmount bag prior to connecting onto the control box (see figure 8).
- g) Connect the coil connector to the socket on the rear of the control box and tighten the locking nut.

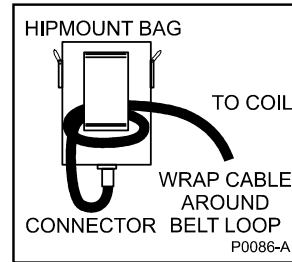

Figure 8 - Hipmounting the Control Box

4. Batteries

Your Eureka Gold is supplied with a rechargeable 12 Volt NiMH battery pack and mains charger. A car charger is also available as an accessory item from your authorised Minelab Dealer.

4.1 Installation of NiMH Battery Pack

- a) Ensure your NiMH pack is fully charged.
- b) Place the base of the battery pack at the rear of the battery compartment (A). Push the front edge of the battery pack into position (B). The two battery clips will “click” into position to hold the battery pack in place (see figure 9).

Note: The NiMH battery pack is factory sealed and does not open.

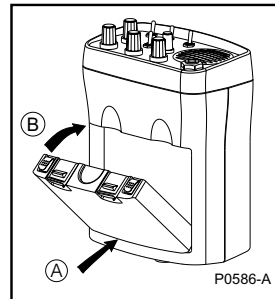

Figure 9 - Installing the Battery Pack

4.2 Installation of Alkaline Batteries

A 12 Volt battery pack to hold 8 ‘AA’ alkaline batteries is available as an accessory item. These are useful to have as back-up if ever your NiMH batteries are flat.

- a) Ensure the detector is switched “Off” before opening the battery compartment.
- b) Slide open the lid on the battery pack.
- c) Place 8 “AA” alkaline batteries (16) into the base of the alkaline pack (15). Ensure they are aligned as shown in figure 10 and as indicated inside the compartment.
- d) Slide the battery lid closed.
- e) Place the base of the battery pack at the rear of the battery compartment (A). Push the front edge of the battery pack firmly into position (B). The two battery clips will “click” into position to securely hold your battery pack in place (see figure 9).

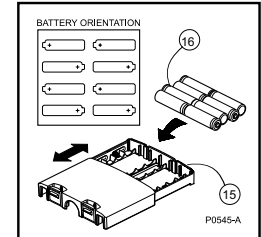

Figure 10 - Replacing the Battery Lid

Caution: Good quality alkaline batteries will power the Eureka for about 10 to 15 hours and should always be used instead of standard carbon batteries. Alkaline batteries should be removed from the detector if it is to be stored for extended periods to avoid damage caused by leaking batteries. Using headphones will extend battery life.

4.3 Low Battery Warning and NiMH Recharging

When the batteries are reaching the point at which they will no longer operate, the Eureka Gold will emit a distinct sharp “pip” from the speaker, approximately every 30 seconds. Shortly after this, the threshold will increase to a loud continuous signal that cannot be reduced by the threshold control. When this tone is heard, it is recommended that the NiMH battery pack be recharged or alkaline batteries be replaced as soon as possible to avoid missing any targets. The NiMH battery pack can be recharged using either the supplied mains powered charger or a 12V charger (available as an accessory) that can be plugged into the cigarette lighter of your vehicle.

Caution: Check the mains charger voltage. Only use the appropriate mains charger for the country you are in.

4.4 Using your NiMH Chargers

Plug the charger into the socket on the rechargeable NiMH battery pack, and plug the charger into the power source and switch on. The car charger has a red light that indicates that it has power. A green light will appear on the battery pack during charging. A completely flat battery will take approximately 12-14 hours to fully charge. The green light on the battery pack will fade/dim once it is fully charged. A fully charged NiMH pack will give between 15 and 20 hours detecting time, depending on the number of targets found.

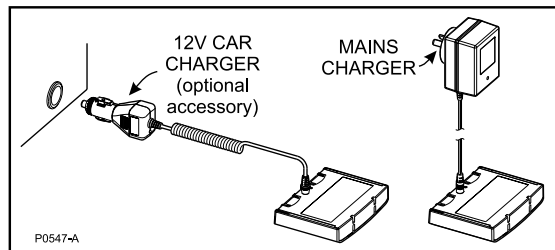

Figure 11 - Car and Mains Battery Chargers

5. The Eureka Gold Controls

This section gives detailed descriptions of the controls of the Eureka Gold detector and their functionality. Having knowledge of these controls means that you will be able to achieve the best performance from your detector. As you gain experience with your detector it may be useful to refer back to this section.



Figure 12 - The Eureka Gold Control Panel

The Control Panel of the Eureka Gold has been carefully designed, especially the placement of the controls, so those you will need to use most frequently are at your finger tips (see figure 12).

5.1 Volume Control

The Volume Control incorporates the On/Off switch. It is off when the control is fully counter clockwise. Turn the Volume Control clockwise and the Eureka Gold ‘clicks’ on.

This control sets a maximum limit on the loudness of the audio signal obtained from various targets. If the Volume Control is close to the maximum, the audio signal is proportional to the target signal level (see figure 13). However, if the Volume Control is turned down, the audio signal is the same for a smaller target, but limited for a bigger target.

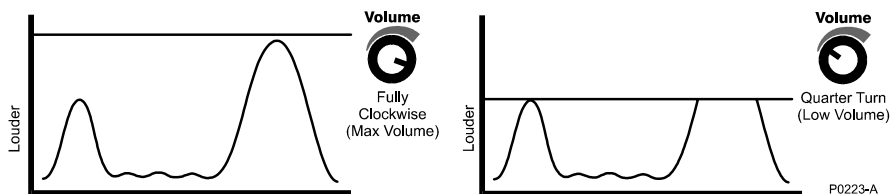

Figure 13 - Volume Control (The maximum audio output (volume) can be limited)

Therefore this control is a volume limiter. It is a useful feature when using headphones, as audio signals which would otherwise be uncomfortably loud can be limited while maintaining full response to small signals.

5.2 Threshold Control

The Threshold Control is used to set the continuous audio ‘hum’ or ‘threshold’ level. The Threshold Control should be set so the threshold level is just audible, e.g. not too loud. Prolonged use at a loud level could be irritating to the operator, and could mask a faint signal.

It is important to know that small targets or large but deep targets may not produce a distinct audio signal, but rather cause only a slight deviation from the threshold level. If the threshold level is set too high or too low, the very small variations in audio signal which indicate very small or deep targets can be missed (see figure 14).

Note: While detecting, the Threshold Control may require occasional readjustment.

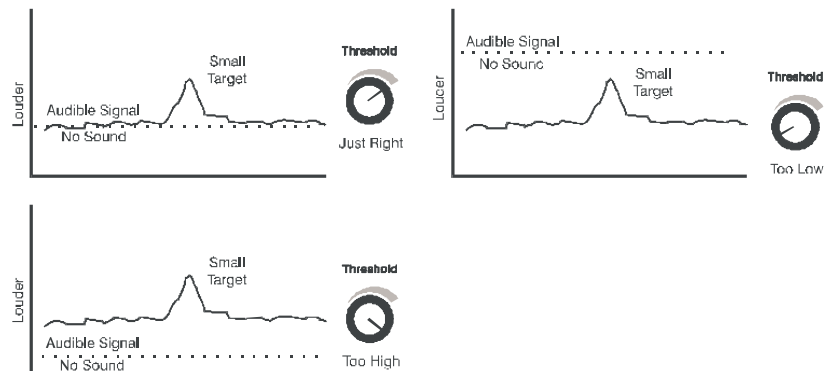

Figure 14 - Threshold Control Settings

In the graphs (on page 13) the dotted line represents the level at which the audio output becomes audible; signals cannot be heard if they are below that dotted line. When the threshold is set correctly it is just above being audible and even small variations in the sound level will be heard. If the threshold level is set too high, then small variations in audio signal might not be discernible above the threshold level. If the threshold level is set too low there is no audible background audio signal and small target signals will not go above the threshold of audibility.

5.3 Sensitivity Control

The Sensitivity Control affects the strength of all signals, small shallow targets, large deep targets, mineralisation and other interferences. The Sensitivity Control also affects the level of sound produced by the detector for a particular target. However, unlike the Volume Control, it affects both small and large targets alike.

It is recommended that in most ground the Sensitivity Control should be set to the maximum sensitivity. This is obtained by turning the control fully clockwise.



Figure 15 – Sensitivity Control
(The audio output is amplified according to the Sensitivity setting)

The Sensitivity Control should be decreased only in case of electrical interference or poor ground conditions such as heavy mineralisation or heavy ironstone. The sensitivity should be decreased just enough to make the detector usable.

5.4 Frequency Switch

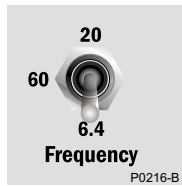

The Eureka Gold has three operating frequencies: 6.4kHz, 20kHz and 60kHz. Usually 6.4kHz is better suited to larger, deeper gold nuggets while 60kHz is better for smaller nuggets near the surface. The 20kHz setting is best for general purpose detecting, or a happy medium between both these extremes.

After changing the frequency setting, there will be a period of 2 seconds when the detector will not detect any targets. Also, it might be slightly out of ground balance, but the Automatic Ground Balance will quickly readjust itself as you start sweeping the ground. If you want to make sure you don't miss any targets, you can 'pump' the detector as explained in the Operating Instructions (see pages 23-25).

5.5 Signal Switch



The *Signal* switch provides three levels of audio response: *Normal*, *Fine* and *Boost*. In the *Normal* position, a target signal is unaffected. A change in the pitch and volume helps to separate target signals from the background threshold tone.

In the *Boost* position, the target signal is amplified, offering extreme depth penetration in quiet soils or in an area with constant ground mineralisation. You are likely to encounter some spurious noise if you search in variable ground using the *Boost* setting. This mode is also useful to pinpoint a target which gives a faint signal under normal circumstances. Noisy (i.e. mineralised) ground will become even noisier if used in this position. The signal will become even noisier if used in conjunction with 60kHz.

The *Fine* position is specially designed to enable the detection of small and medium size targets close to the surface, especially in mineralised ground. It does this by amplifying and filtering the audio signal. This allows the target signals to be amplified without amplifying the background signals as occurs in boost mode. This mode may miss larger targets at greater depths but will give greater sensitivity to smaller targets. Excessive numbers of 'hot rocks' could make this mode undesirable in some grounds.

5.6 Balance Switch



The *Balance* switch selects either *Automatic Fast Track* or *Automatic Slow Track*, or the *Fixed* ground balance position. In the two automatic positions the Eureka Gold is an Automatic Ground Balance detector. This means that the detector continually adjusts itself to maintain ground balance, which will ensure that your detector is

searching to its greatest possible depth at all times. *Fast Track* causes the ground balance to respond rapidly to changing ground conditions, while the *Slow Track* setting responds at about half this rate.

Fast Track being the faster ground balance should be used where the ground is heavily mineralised or changes rapidly. For ground which is more mild or reasonably constant in its mineralisation, use the slower *Slow Track*.

It is important to know that a deep target may be 'balanced' out by continual sweeping over it when pinpointing in the automatic modes. By ground balancing next to the target then switching to the *Fixed* mode, the target cannot be balanced out. For the same reason the *Fixed* mode is recommended when locating targets once dug from the hole.

5.7 Mode Switch (*Discriminate/All Metal*)

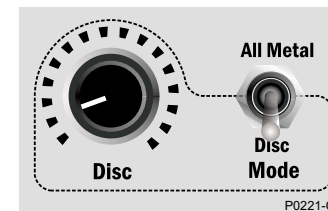

The *Discriminate* switch allows the use of the discriminator built into the Eureka Gold. It has two positions: *All Metal* and *Discriminate*. In the *All Metal* position, the detector responds to all types of targets with the same target response.

In the *Discriminate* position, the detector discriminates between ferrous and non-ferrous targets. The discriminator generally performs best on loud signals. Its ability to Discriminate between ferrous and non-ferrous targets may be affected by the depth and size of a target. Ferrous targets will be signalled by a blanking of the audio threshold. Using the Eureka Gold discriminating mode will not sacrifice sensitivity or depth, but it will not necessarily discriminate to the full depth at which the target can be detected.

5.7.1 Discriminate Control

The *Discriminate* control sets the sensitivity to ferrous objects. At the minimum setting small ferrous objects at shallow depths are less likely to be discriminated, while at the maximum setting these objects are more likely to be discriminated. Large ferrous objects should always be discriminated unless they are too deep.

5.8 Tone



The Eureka Gold has a tone control which allows the operator to adjust the “tone” or “pitch” of the audio threshold signal to suit the individual. Generally, this should be set to the pitch that you find the easiest to listen to.

We would recommend that you experiment by testing on various targets buried at different depths to find the tone that best suits your hearing.

5.9 Headphones



The headphone socket is located at the bottom right corner of the front panel. Headphones used should be of low impedance, but no less than 8 ohms. The socket will accept most mono and stereo headphones with a 1/4" jack.

When the headphone plug is inserted, the loudspeaker is automatically disconnected so that sound only comes through the headphones.

When using headphones, you can adjust the *Threshold* control to a lower threshold level, and outside noises, such as wind, will be less distracting. Using headphones also conserves battery life. If the headphones have a “Stereo/Mono” switch, set it to “Stereo”.

Headphones can significantly increase your chances of hearing a small signal, therefore we recommend their use.

5.10 Coils

The Eureka Gold should only be used with coils that have been indicated by Minelab Electronics as being suitable for use with this model.

The 10" (25 cm) coil supplied with the Eureka Gold is a Double ‘D’ coil, that is, it contains two ‘D’ shaped windings which are partially overlapping. This Double ‘D’ configuration is ideal for locating deep targets in variable mineralised ground.

The Double ‘D’ detection pattern is “blade like” and is most sensitive from its tip to its heel. This makes pinpointing targets easy, and allows more ground to be searched with each sweep, as each sweep has to be overlapped less.

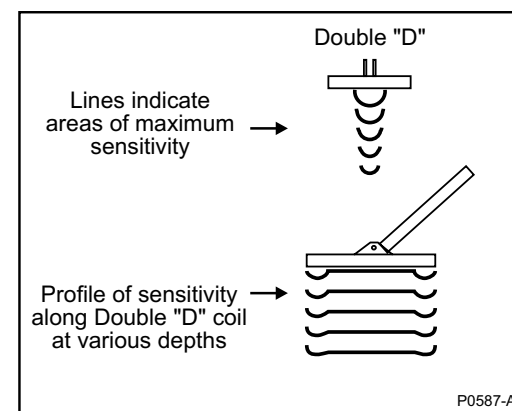

Figure 16 - Coil Search Pattern

In addition to the 10" (25cm) Elliptical Coil supplied with the Eureka Gold, there are two other accessory coils available, the 11" Round and 15" Spider Coils. Both coils will increase the depth of the Eureka Gold on larger nuggets.

6. QuickStart Operating Instructions

- a) Switch *On* the power with the Volume control.
- b) Set the *Volume* control to maximum.
- c) Set the *Sensitivity* control to maximum.
- d) Set the *Threshold* control so that the audio level is just audible.
- e) Set the *Tone* control to a pitch you find comfortable.
- f) Set the *Mode* switch to All Metal.
- g) Set the *Signal* switch to *Normal*.
- h) The *Disc.* control is disabled when in All Metal mode.
- i) Set the Frequency switch to 6.4kHz for detecting large, deep targets or 60kHz for small shallow targets or 20kHz for general purpose searching.
- j) Select the Fast Track (1) for automatic ground balancing in most heavily mineralised ground conditions (see section 5.6 for more information).
- k) Ground balance the detector by raising and lowering the coil just above the ground in an area free of targets. Correct ground balance is achieved when there is no change in threshold hum as the coil is raised and lowered.
- l) Start searching.

Minelab recommends that you read this instruction manual in full, so that you understand the true function and purpose of the controls. This will allow you to select the control settings for different conditions.

6.1 Best Setup Positions

Gold Field Setting

Signal:	Normal
Frequency:	20 or 60kHz
Select:	All Metals
Threshold:	Just audible
Sensitivity:	Maximum
Volume:	Maximum
Balance:	Fast Track or Slow Track

Other Ground Settings (coins/relics)

Signal:	Boost
Frequency:	6.4kHz
Select:	Discriminate
Threshold:	Just audible
Sensitivity:	Maximum
Volume:	Maximum
Balance:	Slow Track
Tone:	Personal Choice
Disc Control:	Minimum

Note: The above are only recommended QuickStart positions. It is better to understand each function and select specific settings for your location. These settings will often change through the course of the day.

7. Detector Sounds

There are seven types of sounds that the detector will produce:

- **Threshold Signal** — A low-level, constant audio hum which is present at all times, even when the coil is held motionless.
- **Target Signal** — Small or large variations in the volume and pitch generally indicate metal targets.
- **Iron Signal** — When the *Discriminate* switch is set to *Discriminate*, ferrous targets will be signalled by a blanking of the *Threshold* signal.
- **Overload Signal** — A high-pitched squeal indicates the presence of a very large target or very highly mineralised ground. To overcome this, raise the coil and test the area again. If mineralised ground is the problem, re-ground balance or try a different signal setting.
- **Discriminator Overload Signal** — A loud 'bell-ringing' sound indicates that the Eureka Gold has detected a signal too large for the discriminator to process accurately. To overcome this, raise the coil from the ground, so that the signal from the target is weaker.
- **Low Battery Signal** — A sharp 'pip' occurs approximately every 12 seconds when the useful charge of the batteries is near its end.
- **Ground Noises** — When passing across rapidly changing mineralised ground, 'ground noises' may be heard. These are often more like long growls than the normal short, sharp target signals. They are often heard when the coil passes across the area from one direction only. The sound is often not heard from the reverse sweep.

8. Operating Instructions – Fundamentals

The Eureka Gold is a motion detector and must be moving over a target to be able to detect it. If the coil is held still for a few seconds, any signals due to ground or targets will die away. The Eureka Gold is designed to be sensitive to a large range of targets while also having the ability to discriminate between ferrous and non-ferrous targets.

When in use, the detector should have the *Threshold* control set so that there is a soft but audible signal at all times. Any variation in this signal as the coil is moved over ground can indicate the presence of a metallic target. It could also, however, be due to sudden large variations in soil conditions for which the automatic ground balance cannot compensate quickly enough. Such differences can be learned through experience.

8.1 Operating the Eureka Gold

- a) Remove the components from the carton and assemble the detector.
- b) Ensure the battery is fully charged.
- c) Turn the Eureka Gold *On* using the *Volume* control. To extend the battery life, avoid leaving the detector *On* unnecessarily.
- d) Adjust the *Threshold* control until the audio signal is just audible when the coil is held motionless. It must be audible, as small targets might not produce enough signal to make any sound if the background sound is too quiet. However, if the threshold hum is too loud, small variations might also be missed because they are too small compared with the background sound.
- e) Once the initial turn-on noises have subsided, turn the *Sensitivity* control to maximum then rest the coil on the ground. Once again, after a few seconds, the noises due to the movement will die down. If there are any residual noises, they will be due to electrical interference with the detector. You will need to slightly decrease the *Sensitivity* control until the interference noises are stable. Reduction of sensitivity reduces the ability to detect targets, so the sensitivity should be reduced as little as possible.

- f) The Volume control is generally turned to maximum. The setting does not affect the threshold level, but sets a limit on the loudest audio signal produced. Test the volume comfort level by passing a piece of metal over the coil. Adjust the *Volume* control to a comfortable level.
- g) Adjust the *Tone* control to a pitch to which your ears are most sensitive. This again allows you to have the threshold set to as low a level as possible.
- h) It is recommended that the *Balance* switch is set to either *Fast Track* or *Slow Track* for general detecting. The *Fixed* setting can be used to hold the ground balance in localised areas when it is suspected that small targets are being balanced out (see Balance Switch on page 17). Leaving the setting at *Fast Track* or *Slow Track* while detecting will ensure that the Eureka Gold continuously adjusts itself to the changing ground conditions. Note that sudden changes in the ground conditions may still produce changes in the audio signal and balancing may need to be repeated.
- i) Move the coil up and down near the ground surface. This allows the Automatic Ground Balance feature to set the balance. Keep 'pumping' the coil until there is no change in the audio signal accompanying the movement (see Figure 17).
- j) Start searching by slowly moving the coil across the ground. Periodically check the control settings to correct for any change in the detector or soil conditions. Refer to 'Detecting Techniques' (see pages 26-30) for details on finding targets.

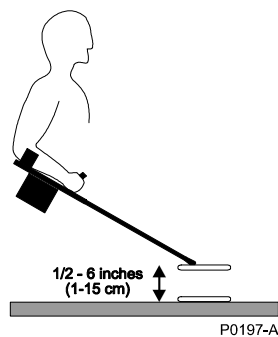

Figure 17 - Ground Balancing

8.2 Ground Balance

Generally speaking, without the ground balance of the detector being set, passing the coil over an area of ground may produce signals whether or not there are targets in the ground. Signals produced without the presence of targets are due to the magnetic and/or mineralised nature of the soil.

To eliminate these unwanted signals the automatic ground balance of the Eureka Gold must be enabled by switching to either *Fast Track* or *Slow Track*. In these modes the Eureka Gold automatically adjusts its ground balance.

When first turning the detector *On*, switch it to either *Fast Track* or *Slow Track* and raise and lower the coil repeatedly over the ground until the audio signal is constant.

In heavily mineralised ground, *Fast Track* will re-balance more rapidly and therefore maintain a better ground balance, however, very weak target signals could be eliminated if repeated sweeps are made across the target. In less mineralised areas, *Slow Track* will maintain a good ground balance without tracking out targets. Once a target has been located, the detector should be put into *Fixed* for pinpointing and digging the target.

Note: It is possible for small targets to be balanced out if the detector coil is swept repeatedly across the target. Once a signal is located, the *Balance* switch should be changed into *Fixed* mode.

9. Detecting Techniques

For best results with the Eureka Gold, it is recommended that you learn some basic detecting techniques such as sweeping, pinpointing and digging targets.

9.1 Sweeping

One of the most important detecting techniques, and perhaps one of the hardest to perfect, is the sweeping of the coil across the surface of the ground.

The Eureka Gold is a motion detector which means that in order to detect a target the coil must be moving. It is recommended that you use a sweeping motion for the coil while detecting (see figure 18). It is essential that the coil sweeps are overlapped in order to ensure that all ground is searched.

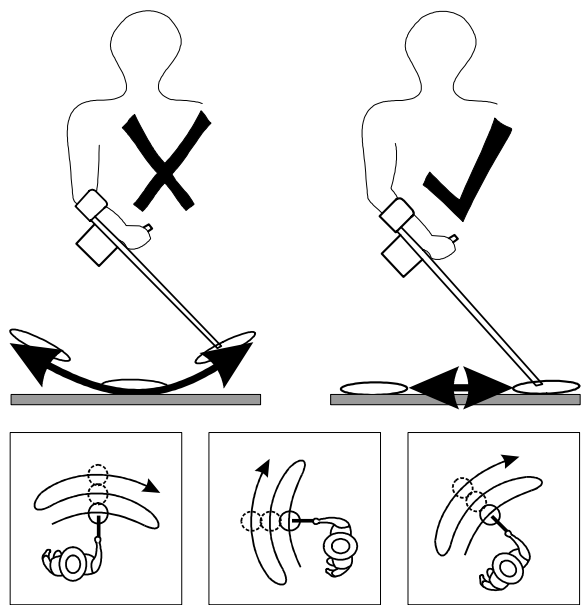

Figure 18 - Sweeping the Coil

Note: Each sweep of the coil should overlap the last one. This will ensure good ground coverage.

Sweeping is carried out in a uniform motion along the ground to cover the search area. Keep the coil parallel to the ground at all times and be aware that there is a tendency for the coil to be raised at the end of each sweep (see figure 18). Each sweep from one side of the body to the other should take between 2 and 4 seconds to complete. This speed will depend on the soil conditions and on the area in which you are operating. Variation in coil height at the end of each swing can cause confusing sounds and will reduce detection depth. Increased noise can also result from hitting rocks, etc. Where possible, keeping the coil in contact with the ground will increase detection depth and sensitivity to very small targets.

9.2 Pinpointing the Target

When a target has been detected, it is necessary to accurately determine its position to enable the operator to recover it quickly and minimise any damage to the environment.

You should switch back to the Fixed Ground Balance position to pinpoint the actual location of the detected target. Sweep the coil over the general area taking note of where the strongest signal is received as the coil is moved over the target. By decreasing the length of the sweep it should be possible to draw an imaginary line in the ground where the strongest signal is located (see figure 19). The side of your boot can be used to mark the ground along this line.

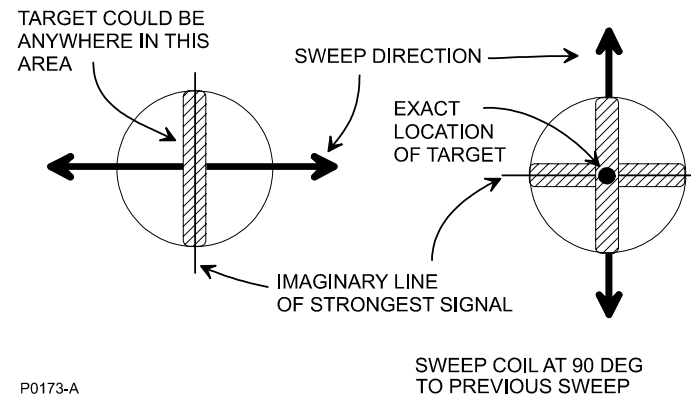

Figure 19 - Pinpointing the Target

The target could be anywhere along the length of the coil from head to toe. In order to pinpoint its exact location, it will be necessary for you to turn at a 90 degree angle and repeat the sweep across the target.

Again take note of the point where the strongest signal is and draw another imaginary line in the ground. Where the two imaginary lines cross is where the target is located. Use the side of your boot to mark this location if necessary.

9.3 Digging the Target

Always remember that when digging, the hole should be kept as small as possible to keep the size of the hole to a minimum.

Dig carefully as a heavy blow can split a nugget, causing a drop in its value. All holes dug must be filled in once the target has been recovered.

It is advisable to have some sort of digging tool when searching. Useful tools are:

- A small hand pick with pointed end and wide blade the other end.
- A small strong digging spade.
- A small knife for grassy areas.

Before digging, clear the surface material and check that the signal is still there. If there is no longer a signal, then the target must be amongst the surface material and is possibly trash. If the signal is still there, dig down a few centimetres. Dig a dish-shaped hole; any sharp edges of soil might cause a false signal.

If the target is not visible, sweep the coil over the hole. The signal should become louder so continue to dig. If the signal has gone then the target should be in the pile you have just dug. If the target is not clearly visible, you might need to scan the soil which has been dug up, so be sure to pile the soil carefully while digging.

The target can be located in this soil by the following methods:

- a) When digging and locating the target, ensure the *Balance* control is set to *Fixed*.
- b) Sweep the coil over the pile of soil to locate the target. Be sure that there are no targets buried under the soil directly below the pile.

- c) Lay the detector down with the coil flat on the ground, near the hole.
- d) Pick up a handful of soil from the pile where you located the target and pass it across the coil. If there is no signal then place the soil in a second pile away from the first and grab another handful from the same area of the pile. Continue this process until the target is in your hand. Look through the soil in your hand until you find the target.
- e) If the target is not obvious, dribble the soil slowly from your hand onto the top of the coil and listen for the target signal.
- f) Then use your fingertip to nudge any suspect items on the coil. The detector will signal when the target is moved.

Once the target has been recovered it is a good idea to run the detector over the hole again to make sure that there are no other targets to be found. When you have recovered all targets from the hole, it is advisable to search the surrounding area carefully as there is a high chance that more targets will be nearby.

9.4 Automatic Ground Balancing

These simplified diagrams (see Figure 20 overleaf) show how Automatic Ground Balancing with the Eureka Gold allows you to detect to its maximum depth at all times.

The top diagram shows normal searching without Automatic Ground Balancing. Ground mineralisation reduces the effective searching depth when you move from where you last ground balanced. The shaded area shows ground which is not properly searched.

The centre diagram shows how a hardworking, experienced professional with a manual ground balance machine will reduce this effect to a minimum. The detector is rebalanced more often, and this is very time-consuming.

The bottom diagram shows how genuine Automatic Ground Balancing covers all the ground quickly and effectively. This ensures that the detector with automatic ground balancing will give optimum depth at all times. For this to occur, the detector must balance quickly enough and still retain sensitivity.

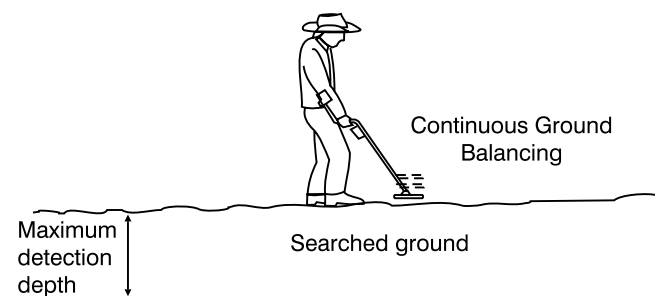
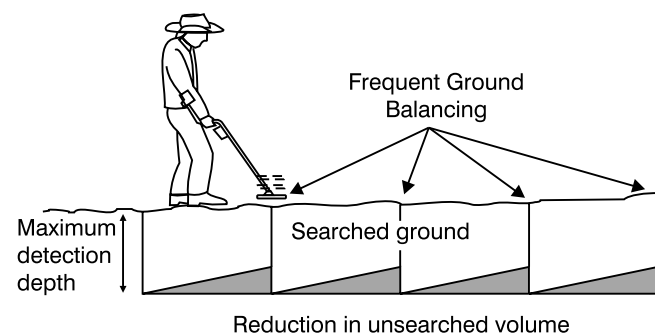
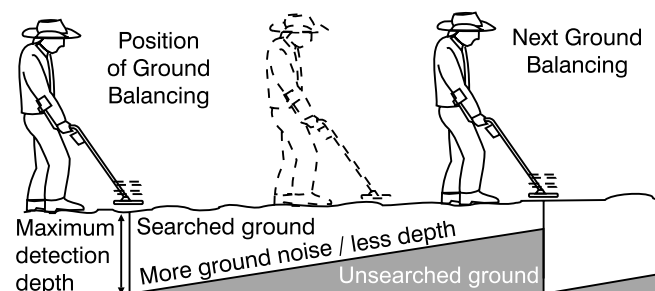

Figure 20 – Automatic Ground Balancing

P0226-B

10. Discrimination

10.1 Discrimination of Iron Targets

When the *Discriminate* switch is set in the *Discriminate* position, the Eureka Gold is able to discriminate between ferrous (iron) and non-ferrous targets (valuables).

A unique feature of the discriminator is its ability to read the degree of ground interference during discrimination. The detector automatically adjusts its discriminating power depending on the type of ground present, thereby achieving the maximum reliable discrimination depth.

Therefore in 'mild' ground the detector will discriminate accurately at greater depth, while in 'hot' ground, the discrimination depth is reduced to maintain reliable discrimination. At all times, however, the depth and sensitivity that the Eureka Gold picks up targets is not reduced.

Be aware that if the detector coil is held in the air or stationary over ground for an extended period, the discrimination sensitivity increases to maximum. If it is then used on 'hot' ground, false discrimination signals will appear.

It is important to keep the coil swinging in a smooth motion at all times. After a short time, however, the detector will adjust to its new condition and the sensitivity of discrimination will automatically be set correctly.

To obtain the best performance out of your discriminator we suggest you take advantage of the multiple frequency features of the Eureka Gold. The best frequency for discrimination is 6.4kHz, followed by 20kHz and then 60kHz. It is best to:

- Search for gold at 20kHz or 60kHz in Fast Track or Slow Track mode.
- Check the ferrous nature of a located target in *Fixed* mode at 6.4kHz.

10.2 Discriminating in 'Hot' Ground

If detecting in *Fast Track* or *Slow Track* and the detector is in *Discriminate* mode, there are several techniques that must be followed for accurate discrimination. As mentioned earlier, the Eureka Gold incorporates a unique feature that adjusts the sensitivity of the discrimination, depending on the ground conditions.

If the detector is swept across the target more than once in 'hot' ground it is possible that the detector's automatic features will adjust the balance to the target and not discriminate out a ferrous target on subsequent passes. This is normal behaviour for an automatic ground balance detector.

Because of the different speeds of adjustment in the two ground tracking modes there will be a difference in the speed of this automatic adjustment. In *Fast Track* only the first pass over the target will achieve accurate discrimination. In *Slow Track* the first two passes are accurate.

To ensure that you are not digging ferrous targets it is best to carry out the following procedure once you suspect a target has been discriminated:

- Move the detector off the target and ground balance the detector over metal-free soil.
- Set the detector in *Fixed* balance mode.
- You can now pass the coil over the target as many times as you like and the discrimination will be accurate.

10.3 Discriminating within Holes

The discriminator must not be used to test a target by pumping the coil into the hole. Always pass the coil smoothly across the top of the hole. Moving the detector coil within the hole will often produce a 'non-ferrous type' target signal when the target is really ferrous.

Similarly, the discriminator should not be used to test a target within the pile of soil which has been taken from this hole as again 'non-ferrous type' signals are likely to occur, particularly in highly mineralised ground. The discriminator will give the most reliable result when the target is tested while it is on or within undisturbed ground.

When the search coil is passed over large targets near the surface, the discriminator electronics may sometimes overload. This is indicated by a high pitch 'chirp' or 'bell-ringing' sound. Sweep the search coil further above the target or so that the target signal is less strong.

11. Prospecting Tips

It will take time and practice to learn how to recognise which signal to pay attention to or to ignore.

The Eureka Gold is particularly good at minimising 'ground noises', and this is the reason for the exceptional depth capability. However, even with this detector some ground noises may occur, particularly in heavily mineralised ground.

11.1 Mineralisation and Hot Rocks

Typically, heavily mineralised ground can make a detector respond with an indication that there may be a target reasonably deep beneath the surface. The sound is normally rather broad and not very loud, but occasionally it may be crisp and reasonably sharp. Other noises which most affect detectors are caused by 'hot rocks'. These are rocks rich in minerals which can produce very strong audio signals. With the strong ones, some detectors have problems in tuning them out, but with the Eureka Gold signals from 'hot rocks' are not as great a problem.

If you find a signal which may be due to mineralisation, but is 'positive' enough to make you suspect a deep target, pass the coil in a circular path around the area, without passing directly over the target. After two or three rotations, pass the coil directly over the centre and listen to the 'positiveness' of the signal. Repeat this procedure but this time sweep at right angles to the previous pass. If both passes result in a significant positive response, then dig!

It is possible for gold nuggets to be entirely encased in rocks, so thorough checking is necessary to ensure no gold is missed. Breaking rocks in two, then passing each section of the rock across coil, one after the other, will determine which piece contains the gold.

Sometimes negative 'hot rocks' or ground 'holes' are encountered. In this case the sound from the detector is reduced as it passes over the rock or 'hole'. Nevertheless, the detector, on recovering from this loss of sound, can give an audible signal which, to the beginner, may be confused with the sound of a target. Experience will soon enable the operator to recognise this characteristic sound which is in fact quite different from a target. Setting the *Signal* switch to *Fine* may reduce this problem.

11.2 Clay Domes

A common occurrence in nugget-bearing country is soil mineralisation commonly known as 'clay domes'. These are regions of rather broad sound which could be confused with the sound which would come from a large deep nugget.

The following procedure will quickly establish whether or not the sound comes from clay or a metal target:

- a) Pinpoint the target as best you can.
- b) Remove about 4 cm (1.5") depth of soil from over the target response. Dish the hole so that there are no sharp edges around the hole.
- c) Sweep the coil across the target from a few directions, keeping the coil as low as possible. Listen to the signal and note if it is:
 - Any louder or more defined than before. By bringing the coil closer to a metal target the signal should become louder.
 - Note if the signal seems to come from one direction only (a mineral signal will often come from one direction only, or at least be less defined from the return sweep).
- d) If you are still not sure, continue to dig deeper and again, note the points above.
- e) Be sure to dish the hole when digging to ensure there are no sharp edges. Sweeping the coil across the sharp edge of a hole can cause false spurious signals due to the change in distance between the ground and the coil.

11.3 Charcoal

Charcoal can sound loud and rather like a metallic target when close to the surface. Charcoal is usually created by farmers burning off tree stumps or by bushfires. The growth is burnt below the ground level, so it is not always obvious what the sounds are until you have actually dug up the causes of these noises a few times. Again, experience will teach the operator how to read the ground efficiently and gain understanding of the detector's response to the ground.

An indication of charcoal is that the sound seems very spread out and becomes patchier as the ground is dug. Inexperienced operators should continue to dig until the reason for the signal becomes clear.

11.4 Gold Lore

To have a good chance of detecting gold, it is necessary to search out areas where 'coarse gold' is known to have been found, or other areas where it is likely to occur. The term 'coarse gold' refers to gold ranging in size from a grain of wheat to many grams, and in some cases many ounces.

Many nugget-bearing areas are the result of broken-down gold reefs containing quartz and ironstone. Experienced prospectors learn to 'read the ground' and look for tell-tale signs indicating potential gold-bearing fields. It is a fascinating and exciting hobby to learn some of these skills and apply them in your search for gold.

The modern metal detector has given today's prospector enormous advantages over the prospectors of old. The ground can be rapidly scanned until a small piece of gold is found and then a study of the area made to decide where other gold nuggets are likely to be located. It is then best to make a systematic search of the area.

The main problem encountered while using metal detectors is the presence of heavy concentrations of ironstone. This is particularly the case in some of the richest known fields in Australia or the 'black sands' areas of North America. It appears that gold nuggets and ironstone often go together, and in fact many gold nuggets have ironstone embedded in them or are encased in ironstone and others show strong ironstone staining. Some of these fields have only been superficially worked by detectors because of the interference caused by the ironstone. Usually only the most persistent professional is prepared to spend the time and energy necessary to cope with these conditions and then only partially.

12. The Coil and Skidplate

Over a long period of time the Coil Skidplate will wear if the ground is scrubbed continuously while searching. Minelab agents can supply a replaceable skidplate for the Coil. This can be fitted by removing the existing plate and pushing on the replacement skidplate (see Figure 21). Skidplates are inexpensive and it is recommended that you protect your coil by regularly replacing the skidplate.

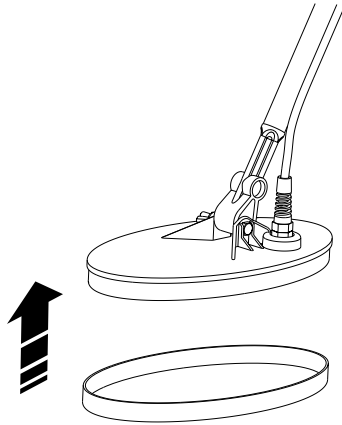

P0584-A

Figure 21 - Skidplate to Protect Coil

Hint: The use of non-metallic tape around the edge of the coil/skidplate will help to prevent the ingress of dirt or moisture.

13. Environmental Concerns

Firstly, it should be pointed out that gold prospecting and treasure hunting with a metal detector is the most environmentally friendly way to recover nuggets, coins, rings, and other treasure items. However, it is important to leave an area that you have searched in the same condition as you found it.

All holes that have been dug must be properly refilled. Not only is it environmentally unacceptable to not fill in your holes, it is also very dangerous. There are special tools to enable you to recover targets easily from grassed areas without digging large holes.

Take away and properly dispose of any junk that you find or produce, such as nails and tin cans. Use a rubbish pouch on a belt to collect the rubbish while searching and dispose of it environmentally when you return home. Leaving an area 'scarred' can result in action being taken to prevent the use of metal detectors, which spoils this fascinating hobby for others as well as yourself.

14. Care of the Eureka Gold Detector

The Eureka Gold is a high-quality electronic instrument, finely engineered and packaged in a durable housing. Proper care and maintenance will ensure long-term reliability of the detector.

Please observe the following precautions:

- Do not leave the alkaline batteries in the control box when the detector is not in use. Damage caused by leaking batteries can be severe and will void the warranty.
- If temperatures are very high, do not leave the detector in the sun for longer than necessary. Covering it when not in use will help protect it. Try to avoid leaving it in a closed trunk or behind glass sitting in sunlight.
- While the control box has been designed to be water-resistant, it is not waterproof. Avoid wetting it unnecessarily. Never allow the box to come into contact with gasoline or other oil-based liquids.
- Keep the unit (especially connectors) clean and dry, and avoid getting sand and grit into the shafts. Do not use solvents to clean the detector. Use a damp cloth with mild soap detergent.
- Flat or faulty batteries cause many detector problems. Ensure that you use only Minelab NiMH rechargeable batteries and that they are recharged as soon as the 'Low Battery' warning signal is heard. Ensure that only quality alkaline 'AA' batteries are used and that they are replaced when the warning signal indicates.
- Ensure that you only use Minelab's NiMH battery charger as per previous instructions.
- Ensure the coil cable is in good condition and not subject to undue stress.

- If any part of the detector comes into contact with corrosive substances (including salt or salt water), wash it with fresh water.
- Use of a padded transport bag or case can protect your detector from scratches and bumps while transporting in the vehicle.
- The hipmount bag is designed to protect the control box, especially from dust, mist and rain. It will also cushion potentially damaging knocks. Use the hipmount bag where possible.
- The Eureka Gold is a very sensitive VLF radio receiver. There are many external sources of noise that may affect the performance of the detector, including another detector in close proximity, high power transmitters, power lines and electric fences.
- Do not open the control box or attempt to alter the detector in any way. Doing so will void your warranty.

14.1 Trouble-shooting Guide

Fault	Solution
No Sound	Check battery and battery connections Check Headphones and their connection
Erratic Noises	Check battery charge and battery connections Ensure coil plug is tightened firmly Reduce the sensitivity by turning counter-clockwise Switch out of 'Fixed' ground balance position Check and adjust the ground balance Check headphones and their connection Check for sand or grit between skid plate and Coil
No Target Response	Ensure unit is turned 'On' Check battery charge and battery connections Check coil connection Check headphones and their connection

In the unfortunate circumstance that you need to return your detector to Minelab for service, please fill out a copy of the Minelab Service Repair Form on page 44 and enclose it with the detector. Please supply as much detail as possible about the fault and warranty details, as this will assist our service engineers to rectify the problem quickly and efficiently.

15. Warranty and Service

There is a two-year parts and labour warranty for the Eureka Gold electronic Control Box. The Coil, Shafts, etc., are warranted for one year. Refer to your Warranty Card for further details. Always refer to your supplier or Minelab for service, either in or out of warranty.

Note: This warranty is not transferable, nor is it valid unless the enclosed warranty registration card is returned to Minelab Electronics Pty Ltd or an authorised Minelab Electronics Pty Ltd regional distributor within 14 days of the original purchase.

The Minelab warranty does not cover damage caused by accident, misuse, neglect, alteration, modifications, or unauthorised service. For specific details of the Minelab warranty, please refer to the 'Product Warranty Card'.

16. Specifications

These specifications are subject to change without notice.

Length:	Packed	710 mm
	Operating (min)	1190 mm
		(max)
Weight:	Control Box	740 g
	Complete Unit (excl batt)	2.2 kg
Batteries:	Recharge NiMH Batt Pack	12V, 1.2Ah ~ 20hr
Coil:	10" Double 'D' Elliptical with Skidplate	
Frequency:	Transmission (sine wave)	6.4, 20 and 60 kHz
Ground Balance:	Automatic	2 Speed & Fixed
Search Modes:	Motion Detector	Always
	Balance	Fast , Slow & Fixed
	Discrimination	All Metal and Disc
	On/Off Volume	Control 1 turn
Controls:	Threshold	Control 1 turn
	Sensitivity	Control 1 turn
	Tone	Control 1 turn
	Discriminate/All Metal	Switch 2 Pos
	Discriminate Level	Control 1 turn
	Balance	Switch 3 Pos
	Frequency	Switch 3 Pos
	Signal	Switch 3 Pos
Charger:	110/240V Mains Charger for rechargeable battery	
Warranty:	Control Box	2 Years
	Coil	1 Year
Patents:	Patents apply	

EC Conformity

NOTE:

This product complies with the essential requirements of EMC Directive 89/336/EEC

17. FCC Compliance

NOTE:

This equipment has been tested and found to comply with the limits for a Class B digital device, pursuant to part 15 of the FCC rules. These limits are designed to provide reasonable protection against harmful interference in a residential installation. This equipment generates, uses and can radiate radio frequency energy and, if not installed and used in accordance with the instructions, may cause harmful interference to radio communications. However, there is no guarantee that interference will not occur in a particular installation. If this equipment does cause harmful interference to radio or television reception, which can be determined by turning the equipment off and on, the user is encouraged to try to correct the interference by one or more of the following measures:

- Re-orient or relocate the receiving antenna.
- Increase the separation between the equipment and receiver.
- Consult the dealer or an experienced radio/TV technician for help.

Working for a Cleaner, Greener Future



For Consumers within the European Union: Do not dispose of this equipment in general household waste.

The crossed out wheeled bin indicated on this equipment is an indicator that this unit should not be disposed of in general household waste, but recycled in compliance with local government regulations or environmental requirements.

Please dispose of this equipment via a recycling service or centre, or by returning the unit to the respective Minelab or Halcro outlet as appropriate for your unit. This will enable the equipment to be disposed of in an environmentally safe manner.

Disposal of unwanted electronic equipment in landfilled waste may contribute to adverse long term environmental effect due to the leaching of contaminating and toxic substances contained within some electronic equipment.

Disclaimer:

The Minelab metal detector discussed in this operating manual has been expressly designed and manufactured as a quality hobbyist metal detector and is recommended for use in coin, treasure and general metal detection in non-hazardous environments. This metal detector has not been designed for use as a mine detector or as a live munitions detection tool.

Please note:

Since there may be a variety of options available for this detector, equipment may vary according to the Model or items ordered with your detector. Certain descriptions and illustrations may also differ (in this manual) from the exact Model that you purchased. In addition, Minelab reserves the right to respond to ongoing technical progress by introducing changes in design, equipment and technical features at any time.



THIS DEVICE COMPLIES WITH PART 15 OF THE FCC RULES

Operation is subject to the following two conditions: (1) this device may not cause harmful interference, and (2) this device must accept any interference received, including interference that may cause undesired operation.

Item Number: 4901 - 0046
Revision: 3

MINELAB ELECTRONICS PTY LTD

Telephone: +61 (0)8 8238 0888

Email: minelab@minelab.com.au

MINELAB INTERNATIONAL LTD

Telephone: +353 (0)21 423 2352

Email: minelab@minelab.ie

MINELAB AMERICAS INC

Telephone: +1 630 401 8150

Email: info@minelabamericas.com

www.minelab.com

